



泰陽
Since 1967
SUN



RUBBER WORKS

ROAD SAFETY

GREEN SUN

SUN RUBBER CO., LTD
SUN ROAD SAFETY TECH. CO., LTD



ABOUT SR



Sun Rubber Works Co. Ltd. was founded in 1967. We supply a wide range of industrial rubber products including rubber cylinder rollers, packing products, pads, oil seals, sander wheels and 4-sided/Moulder rubber rollers which contain precision rollers, electronics, office machines, plastic bags, sealing machines, expansion rollers & roller attachments and even large paper mill rollers. Our packing products consist of oilrings and engineering packing products such as track pads, hull materials for ships, bridge and highway crash cushions and equipment for hydraulic (thermal) power plants.

In 1990, we've successfully developed and patented a product, the Sun Sander Wheel, a revolutionary product for polishing metal, which can be used to polish golf balls, bathroom faucet handles, water heating equipment accessories, lock accessories, lamps, metal furniture pedestals, hand tools and hardware, and which are sold quite well in Taiwan, China and Southeast Asia.

With the aim of innovation and improvement, Sun Rubber Works Co. Ltd. Has continuously devoted itself to researching and to manufacturing rubber products. The quality of our products and services are accepted and appreciated by our customers and peers. We have imported a complete outfit of machinery to elevate our production capacity. Moreover, we have also obtained the patents for our products in China, Taiwan, America, Germany and Australia, along with ISO certification. We have been not only researching and developing new products according to our customers' needs, but also maintaining a collaborative relationship with academic and research institutions in terms of technical development.

1997, Sun Rubber Works Co. Ltd. has transformed from being a supplier of traditional industrial machinery spare parts to Sun Road Safety Tech. Co., Ltd, which supplies many facilities for traffic safety, parking protection and storage anti-collision. People are paying more and more attention to the safety in their surroundings today. Supplying high-performance safety products with environmental protection, simple design, reflective warning, and shockproof structure is quite helpful and effective for total security and aesthetic upgrade of road constructions, public area of government agencies, schools, companies, factories, parks, and residential communities.



Sun Rubber Works Co. Ltd. has not only companies and factories in Taiwan but also production lines in ShekPai Town and HouJu Town, Dong-guan City, Guang Dong Province in China. There are two liaison offices in charge of the sales operations in Shanghai. We have distributors throughout the country. We also cooperate with suppliers in China to ensure a stable procurement and a contracting center to control product quality strictly so they will manufacture under license. We can manage order lists directly to expand product chains so that we can have established a substantive market share in the Middle East, the Philippines, India, and Australia in recent years.

Recently, our President Shin-Min Chen has devoted himself to the classification of waste reduction and recycling and firmly invested tens of millions of dollars as R&D funds in rubber waste processing so as to enhance the high-value engineering of traditional industries with the control technology for rubber and plastic alloys including rubber ground tiles, parking curbs, corner guards, formworks of traffic islands and pavements, industrial reusable pallets, environment-friendly artificial marble stones, recyclable grass' barber and rubber wall tiles, which were awarded SBIR (Small Business Innovation Research) Phase II promoting program in 2007 & SBIR Phase II+ in 2009 with millions of dollars in government project grants for two consecutive years. We have successfully produced the "Green Plate" with high quality, durability and artistic design, which has many advantages such as thermal and sound insulation, rapid installation, artistic design, Nano surface, dust pollution prevention and elimination of moss. This product has gained access to the building materials industry and construction works.



RUBBER WORKS

METAL ROLLER	02
PRINT ROLLER	03
TEXTILE ROLLER	04
ANTI-SLIP/SANDING/SANDING ROLLER	05
SILICONE ROLLER	06
RTV ROLLER/BANANA ROLLER	07
RUBBER CASTER WHEEL/SEMI-PNEUMATIC TIRE	08
SANDER WHEEL/POLISHER WHEEL 4 SIDE MOULDER ROLLER	11
GUIDE WHEEL/CENTRIFUGAL WHEEL/ALUMINUM CORE ROLLER	12
RUBBER HYDRAULIC PRODUCTS	16
RUBBER CUP WAD/RUBBER CUP SETS/SILICONE COVERS FOR MICROWAVE	17
RUBBER SHEET SERIES	18

ROAD SAFETY

CORNER GUARDS	19
FOAMING CORNER GUARD	20
CORNER GUARD	21
FLEXIBLE BOLLARD (ROAD FLEXIBLE DELINEATOR)	22
PARKING CURBS (PARKING BUMPER/WHEEL STOPS)	23
WHEEL CHOCKS	24
RUBBER DOCK BUMPER	25
SPEED HUMPS (SPEED BUMPERS)	26
(RAISED) REFLECTIVE PAVEMENT MARKERS	27
WIRE PROTECTORS	28
ROAD LIGHT REFLECTION MARK	29
TRAFFIC SIGN BOARD	31
CONVEX MIRROR	32
TRAFFIC CONE BAR/TRAFFIC CONE	34
HELMET/STRING FLAG/BARRICADE TAPE/INDOOR CAUTION BOARD	35
WARNING LIGHT	36
TRAFFIC BATON/SAFETY VEST/TACTILE WALKING SURFACE INDICATORS	37
PARKING LOCK	38
BARRIER (FIXED/MOVABLE)	39
OTHER SERIES	41
PARKING SPACE COMBINE BAG	43
GREEN PLATE	

GREEN SUN	44
GREEN SUN PREFABRICATED HOMES	46
DEDICATED ANTI-SLIP MATS	51
TREE GRILLE /PAVER BLOCK	52
CULTURAL INNOVATION	
CULTURAL CREATIVE	53

● METAL ROLLER



High Pressure Roller



Sanding Roller

Expander(Spreader)Roller



Banana Roller



○ PRINT ROLLER

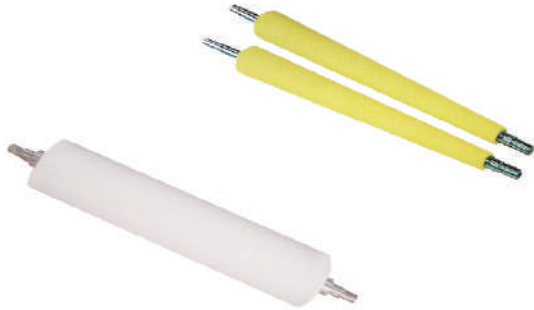

Conveyor Roller



Paper Feed Roller



Paper Feed Roller



Pinch Roller



Print Roller

● **TEXTILE ROLLER**



Teflon Roller



PU Roller



EPDM Roller



Mercerized Roller(Textile Roller)



Dyeing Roller



Coating Roller



Pinch Roller

○ ANTI-SLIP/ SANDING/ SANDING ROLLER



Anti-Slip Roller



Driving Roller



Sander Roller



Brush Roller

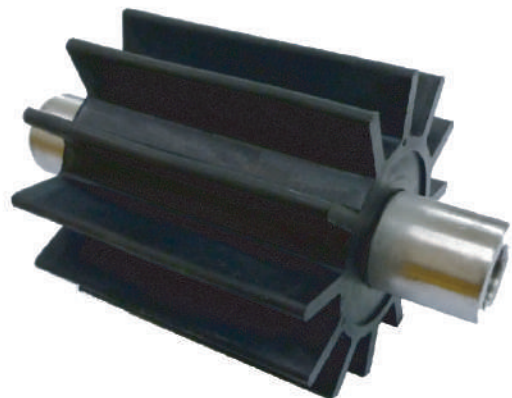

Rubber Roller

● SILICONE ROLLER



Silicone Roller

Pinch Roller



Silicone Roller

● SILICONE ROLLER

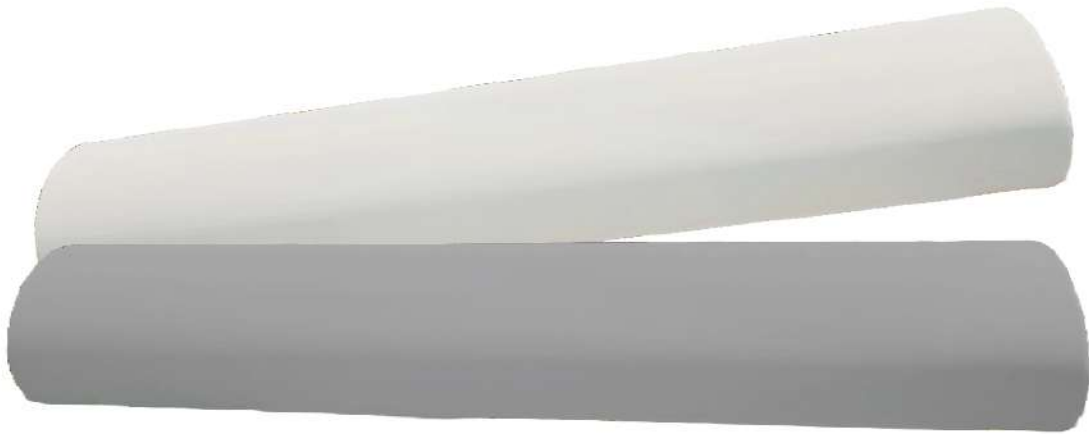

RTV SILICONE ROLLER

● BANANA ROLLER



BANANA ROLLER

RUBBER WORKS

Size tolerance $\pm 5\%$

○ RUBBER CASTER WHEEL/SEMI-PNEUMATIC TIRE

Front View

End View



P-0-APU001-1
P-0-APU001-2

100 ϕ X50mm
iron plate 145X115X100mm

SEMI-PNEUMATIC TIRE



R-0-201000-2
whole set 90X40mm
 ϕ 50mm X20mm
Iron plate 30X80mm

● SANDER WHEEL/POLISHER WHEEL



○ SANDER WHEEL



Taiwan Patent No.: New No. 129128

● **4 SIDES MOULDER ROLLER** (For Woodwork Machinery)

4-side Planer Rubber Roller



PU Roller



Polisher Rear Wheel

○ GUIDE WHEEL/CENTRIFUGAL WHEEL/ ALUMINUM CORE ROLLER



Centrifugal wheel



Guide Roller



Foaming Roller

● RUBBER HYDRAULIC PRODUCTS



Silicone Pad/Seal Ring



Silicone Stripe



Thermally Conductive
Silicone Film



Silicone Parts



Silicone Accessories



Miscellaneous Items



Silicone Envelope

○ RUBBER HYDRAULIC PRODUCTS



PU Seal



Insulation Parts



Oil Seal for Car Chassis

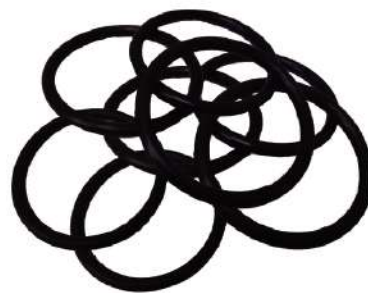

O-Ring

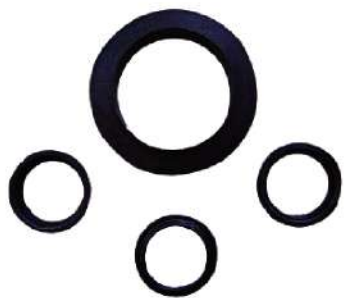

Mechanical Seal



Pad

● RUBBER HYDRAULIC PRODUCTS



Coupling



Coupling



Silicone Oil Seal



Button



Shock Absorber



Buffer Pad



Fitness
Equipment Handle



Mechanical Slide Baffle



Leveling Feet

○ RUBBER HYDRAULIC PRODUCTS



Fluorine Rubber



Rubber Mat



Rubber Ring



Rubber Belt



Rubber Handle



Rubber Pad



Rubber test Sample



Rubber Tube

● RUBBER CUP WAD/RUBBER SETS/SILICONE COVERS FOR MICROWAVE

Rubber cup wad / lid, silicone covers for microwave

Character

Non-toxic, non-slip, artistic, durable, safe, environment-friendly

Application

Mouthwash cup wads, tea cup wads, mug cup wads, microwave covers, food dust covers, refrigerator fresh covers, etc.

Applicable Temperature

Rubber - 10°C ~ 95°C

Silicone - 35°C ~ 200°C

Customizable according to the demanded quantity of each enterprise

(logo/text pattern/color/size)



Rubber Cup Wad

Rubber Cup Sets

Silicone Covers for Microwave

◎ RUBBER SHEET SERIES



Horizontal rubber plate

R-6-000008

Thickness 3mm/5mm

Customizable according to the demanded quantity of each enterprise

Roll cloth thorn skin

C0248

Thickness 3mm/5mm

Customizable according to the demanded quantity of each enterprise

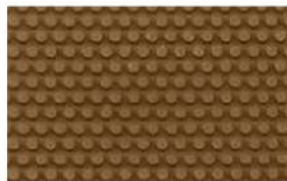

Rubber Sheet Series

Black/green/white

Thickness 5mm

Customizable according to the demanded quantity of each enterprise

CORNER GUARDS



CG-0-00-01
CG-0-01-01
CG-0-02-01

CG-0-00-02
CG-0-01-02
CG-0-02-02

CG-0-00-03
CG-0-01-03
CG-0-02-03

CG-1-00-04
CG-1-01-04
CG-1-02-04

CG-1-00-05
CG-1-01-05
CG-1-02-05

Curved Corner Guard

CG-2-01

845X170X100mm

Special colour
MOQ requirement

88x88x552mm
88x88x890mm
88x88x1200mm

**Plastic Color Stripe
Corner Guard
Black/Yellow**
CG-90 B/Y
86X86X900mm
CG-120 B/Y
86X86X1200mm



**Fluorescent Color
Stripe Corner Guard
(With aluminum
plate inside)**
CG-98Y
86X86X900mm
CG-99Y
86X86X1200mm



**DIY Creative
Corner Guard**
ACG-0-01

120X120X880mm



**Bamboo Creative
Corner Guard**

CGB-01

135X135X900mm



ROAD SAFETY

Size tolerance $\pm 5\%$

FOAMING CORNER GUARD



Big L right angle

RP1-1 RP1-2 RP1-3



54X54X13(T)
X1000mm



Small L right angle

RP3-1 RP3-2 RP3-3



30X30X8(T)
X1000mm

Corner guard-large

54X54X13(T)X100mm

RP6-1 RP6-2 RP6-3



Corner guard-small

30X30X8(T)X65mm

RP5-1 RP5-2 RP5-3



Big roll



RP1-6

50X50X13(T)
X4500mm



Small roll



RP7-5



RP7-1



RP7-2

30X30X8(T)
X3000mm



H-beam steel

PCG3-1

1000x50x45 mm



PCG3

950x50x47mm

◎ CORNER GUARD

PU Foam

PCG1-1-2

PCG1-1



63X63X17(T)
X1000mm

PU Foam (SECC inside)

PCG1-85

PCG85-01

CG-100P

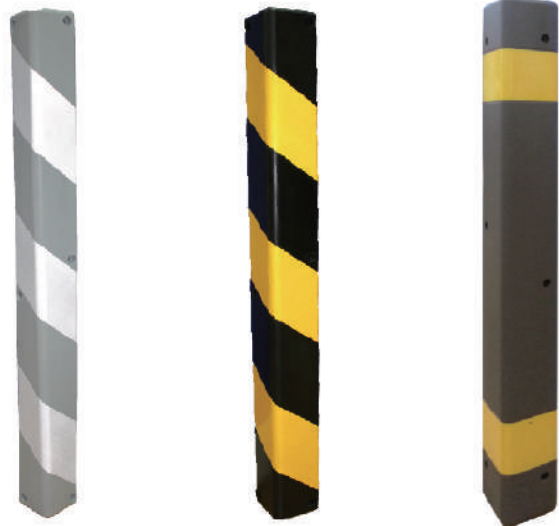

85X85X15(T)
X900mm

100X100X18(T)
X1000mm

PCG1-65

PCG2-1



65X65X15(T)
X1000mm

Column Protector

PCG3-11

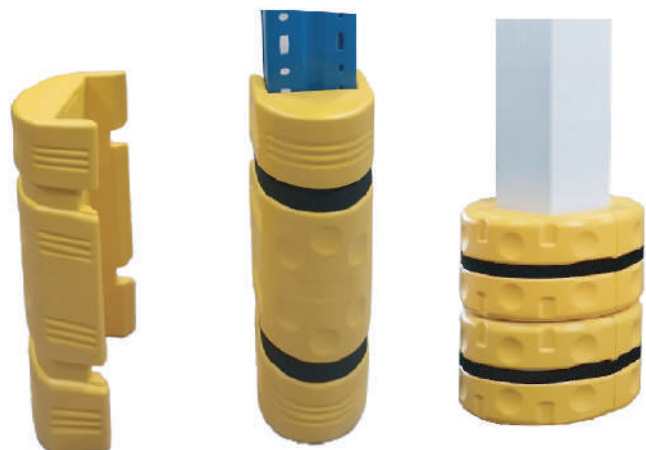

(\varnothing) 100~450mm

ROAD SAFETY

Size tolerance $\pm 5\%$

Taiwan Patent: No.M246355

○ FLEXIBLE BOLLARD(ROAD FLEXIBLE DELINEATOR)

Built-up Warning Bollard

GP-0-0001
88X770mm



GP-0-0002
88X770mm



GP-0-0003
88X770mm



Monkey Shape
88X770mm



Color ALL colors available
Black, Yellow
Yellow, Green
White, Red

PE/PU Flexible Bollard

GP-0-0004
88X810mm



Black, Yellow

Built-up warning bollard
(With flexible post)



PE



PU



80X745mm
110X745mm

Yellow, White

GP-0-0006

GP-0-0008

GP-0-00011-2

GP-0-00011

● **PARKING CURBS (PARKING BUMPER/WHEEL STOPS)**

Rubber Parking Curb (In-line)

SP-02-00
560X160X110mm



Rubber Parking Curb (STOP-STOP)

SP-02-00-1
471X125X85mm



Rubber Parking Curb (STOP)

SP-02-022
520X160X110mm



Rubber Parking Curb (STOP-STOP)(Sports Car)

SP-02-00-2
580X115X80mm



Aluminum Alloy Parking Curb

SP-04-00(Silver)
SP-04-001(Yellow)
550X120X105mm



Rubber Parking Curb (Double Head Cover)

SP-02-011
505X130X130mm

Special color
Have minimum order quantity



PVC Parking Curb

SP-01-60
600X140X120mm



Aluminum Alloy Parking Curb

SP-04-00-4(Silver)
SP-04-00-5(Black)
570X110X113mm



Nylon Parking Curb (Special For Sports Car)

SP-05-00-1
500X100X65mm



PE Parking Curb

SP-01-00
550X135X120mm



Rubber Parking Curb(Long type)

SP-186
1820X145X100mm



ROAD SAFETY

Size tolerance $\pm 5\%$

○ Wheel Chocks



Wheel Chocks
Material:PVC
MPB-01-3
232X175X119 mm



Wheel Chocks
Material:PVC
MPB-01-7
265X270X200mm



Wheel Chocks
Material:Rubber
MPB-01-4
245X175X120mm



Wheel Chocks
Material:EVA
MPB-01-1
232X175X119 mm

Black Warrior Wheel Chocks

MPM-45-01

450X160mm(One group/2 pcs)

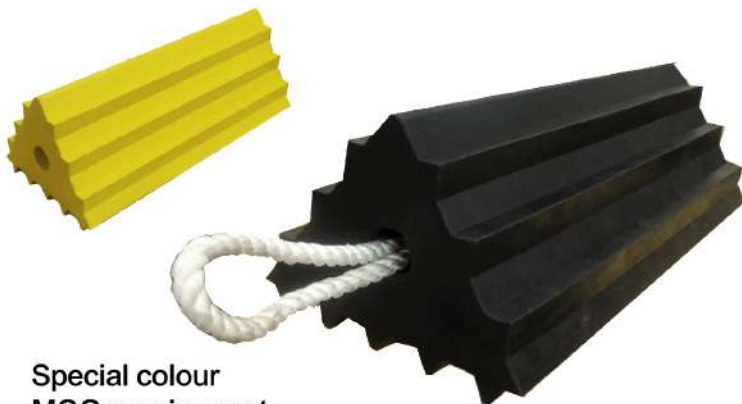

Special colour
MOQ requirement

Special colour
MOQ requirement



Wheel Chocks
Material:Rubber
MPB-01-6
265X125X180 mm

RUBBER DOCK BUMPER



Front

Back

Lateral view



Color
Black

SPM-0-0001
100X100X1000mm
SMP-0-0002
150X130X1008mm

2-hole type

SPM-0-00
440x245x100mm



3-hole type

SPM-0-0012
800X250X110mm



6-hole type

SPM-0-0011
600X250X60mm



PU crash plate
RP-05
900X300X25mm



Rubber Strike-preventing Board
SPM-0-0017
990X198X85mm



Rubber Strike-preventing Board (With arrows)
WP-100
1000X200X10mm



Rubber Strike-preventing Board
SPM-0-0037
990X190X50mm



Rubber Strike-preventing Board
WP-300
1000X200X22mm



Flexional



Rubber Strike-preventing Board
WP-250
980X245X35mm



Fluorescent Strike-preventing Stripe
WP-01
75X27X1000mm



Rubber Strike-preventing Board
WP-200
1000X200X36mm



ROAD SAFETY

Size tolerance $\pm 5\%$

SPEED HUMPS(SPEED BUMPERS)



SPEED HUMPS (big)

- SD-01-A 500X500X50mm
- SD-06-A-2 500X500X35mm
- SD-05-A-2 500X500X25mm

Color
Black+Yellow

SPEED HUMPS (medium)

- SD-02-A 308X500X50mm



SPEED HUMPS (small)

- SD-03-A 134X215X25mm



Three grooves



New Speed Humps (7-paddle)

- SD-08-A-1 134X988X25mm



New Speed Humps (big)

Diagonal Yellow Strip

- SD-09-A 1000X200X30mm



New Speed Humps (medium)

Diagonal Yellow Strip

- SD-09-B 1000X150X30mm

Can be buried



New Speed Humps (small)

Diagonal Yellow Strip

- SD-09-C 1000X100X20mm



○ (RAISED) REFLECTIVE PAVEMENT MARKERS



Plastic nail-in
LRM06-1
107x104x18mm



Plastic nail-in
LRM06-2
107x104x18mm



Aluminum alloy fillet
RS-1-03
100x100x19mm



Aluminum alloy fillet
RS-1-07
100x135x23mm



Plastic fillet
RM-0-00
100x104x18mm



Plastic fillet
LRM-07
100X104X18mm



Aluminum alloy horseshoe
RS-570
124.5X145X36mm



Aluminum alloy horseshoe
RS-571
124X125X41mm

Solar energy LED Pavement Markers

SR-01-01
100x55mm



Rubber fillet

LRM01
104x104x30mm
Yellow



360° Reflective Pavement Markers (Cat eye)

CE-0-000001 / CE-0-000002
Diameter: 10cm
White & Yellow



Rubber fillet

LRM02
104x104x18mm
Yellow



ROAD SAFETY

Size tolerance $\pm 5\%$

○ WIRE PROTECTORS

Wire Protectors-1 groove

WP-001

980X260X65mm



Wire Protectors-2 grooves

WP-02

980X235X45mm



Wire Protectors-3 grooves

WP-03

910X505X68mm



Wire Protectors-5 grooves

WP-05

900X500X50mm



Fixed Wire Protectors-1 groove

SD-04-A-2

995X147X25mm

ROAD LIGHT REFLECTION MARK

(Arbitrary 2 color selection of road reflector)

Adjustable

RS-0-000001 ϕ 100/two sides
 RS-0-000002 ϕ 100/single side
 RS-0-000003 ϕ 100/single side



Immovable 185mmX ϕ 100

RS-0-000004 ϕ 100/single side
 RS-0-000005 ϕ 100/single side
 RS-0-000006 ϕ 100/two sides



PP Roadside Reflector
 205mmX ϕ 118

RS07 RS08



PU Roadside Reflector (zigzag)

RS08B
 208mmX ϕ 123



PU Roadside Reflector (diagonal)

RS011
 205mmX ϕ 115



PP Roadside Reflector (diagonal)

RS012
 211mmX ϕ 125



PP Roadside Reflector (diagonal+zigzag)

RS013
 205mmX ϕ 115



PU Roadside Reflector

RS014
 265mmX ϕ 155



U-shaped Duralumin Roadside Reflector (single side/two sides) ϕ 100

NRS-10A NRS-10S



U-shaped Duralumin Roadside Reflector (with two screw holes) ϕ 100

NRS-10U



ROAD SAFETY

Size tolerance $\pm 5\%$

ROAD LIGHT REFLECTION MARK

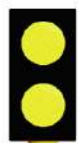

2-circle Reply Type Reflection Mark
TA-2
15X30CM
Material: PE Flexible delineator post
+ PE Black Plate
10cm Round Reflector



3-circle Reply Type Reflection Mark
TA-3
15X40CM
Material: PE Flexible delineator post
+ PE Black Plate
10cm Round Reflector

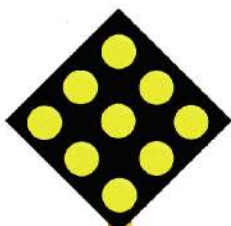

9-circle Reply Type Reflection Mark
TA-9
40X40CM
Material: PE Flexible delineator post
+ PE Black Plate
10cm Round Reflector



Danger 3+ Follow 18 Reply Type Reflection Mark
TA-10
Material: PE Flexible delineator post
+ PE Black Plate
10cm Round Reflector

TRAFFIC SIGN BOARD



Words can be customised

ROAD SAFETY

Size tolerance $\pm 5\%$

○ CONVEX MIRROR

Convex Mirror(Square)



60,80,100cm

Base of convex mirror



Convex Mirror(Round shape)

Material:PC

One piece



Material:Stainless steel
60,80,100cm

No.	Item	Size (CM)
PC30	PC Indoor convex mirror with ABS back	30
PC45	PC Indoor convex mirror with galvanized back	45
PC60	PC convex mirror unibody	60
PC80	PC convex mirror unibody	80
PC100	PC convex mirror unibody	100
SM-48-0001	PC convex mirror unibody	45
SM-80-0001	Stainless Convex mirror SECC back	80
SM-80-0002	Double-side stainless convex mirror	80
SM-60-0001	Stainless Convex mirror SECC back	60
SM-60-0002	Double-side stainless convex mirror	60
SM-60-0003	Indoor convex mirror stainless	60
PCZ60	PC60 Indoor convex mirror with galvanized back	60
PCZ80	PC80 Convex mirror with galvanized back	80
PCZ100	PC100 Convex mirror with galvanized back	100
SM-100-0001	Convex mirror with stainless SECC back	100
SM-100-0002	Double-side stainless	100
SM-45	Square stainless galvanized back	45*60
PCZ-80	Square stainless galvanized back	60*80

ROAD SAFETY

Size tolerance $\pm 5\%$

Guardrail Guide Reflector
RS-0-000008
850X150mm



Anti-collision barrel
CP-01
450X620 x 1000mm



Single side water-fillable Jersey barrier
S-00-001
1000X460X810mm
Yellow/blue/green/orange



Type B Guardian Fence
PH-05
1800X1800mm
Stone wheel
H-1
215x245x120mm

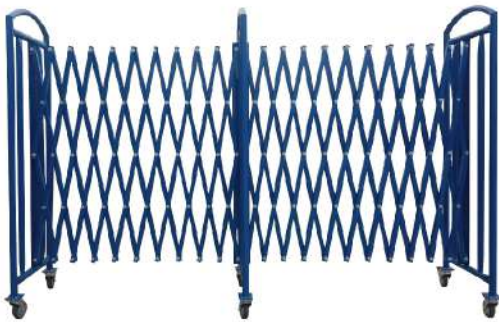

Mobile Retractable Fence with Wheel
PH-06
6M/8M/10M



Queue Fence
GP-1-0012
6M/8M/10M

Plastic Portable Bollard
GP-0-0011-1
65X360X960mm



Plastic Fixed Bollard
GP-0-0011
65X360X960mm



ROAD SAFETY

Size tolerance $\pm 5\%$

TRAFFIC CONE BAR/TRAFFIC CONE

Adjustable Traffic Cone Bar

LK-0-000001

Length: 2M

(Retractable from 1M to 2M)



Fixed Traffic Cone Bar

LK-0-000002

Length: 2M



PVC Mini Traffic Cone

C0222-02

450mm

C0222-01

300mm



PE Traffic Cone

TC-0-000001

700mm



Traffic Cone Holder

TC04

360X360mm



PVC Traffic Cone

C0222-03

Green/750mm

TC-0-000003

Orange/700mm

C0222-04

Blue/750mm



Plastic Ring Sleeve

LK-1-001 Red and White

LK-1-002 Yellow and White

Adjustable Traffic Cone Bar (Color)



◎HELMET/STRING FLAG/BARRICADE TAPE/INDOOR CAUTION BOARD

Engineering Helmet
Customize
PE



HL-0-00

Engineering Helmet
Customize
ABS



HL-1-00

Helmet liner



HL-3-00

Color white/red/blue/yellow/orange

Work shoes



HM-0-00
Long tube

Work shoes



HM-2-00
Short tube

Work shoes



HM-3-00
Color gray/yellow

Indoor caution Board
200X300X600mm



I01

I02

String Flag

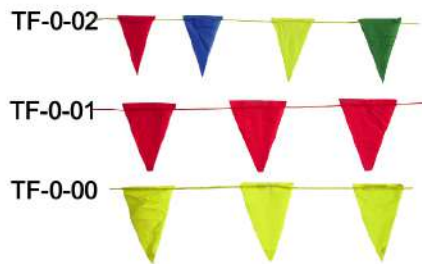

Length 150M

Barricade Tape
8" /6"



W01

W02

ROAD SAFETY

Size tolerance $\pm 5\%$

WARNING LIGHT

Colour
Red/blue/
yellow/green

LED Warning Light
LED01



Lamp Body Diameter: 9cm
Auto sensitive illumination
Continuous Use of 400
hours
Battery: Two D batteries

**Small LED Magnetic
Warning Light**
LED05



Lamp Body Diameter: 9cm
Battery: Two AA batteries
Characteristic: it can stick
to any metal
object with the magnet

**Solar Energy Warning Light
(Small magnetic)**
SLW1-1



Lamp Body Diameter: 9cm
Standard Specification:
Auto sensitive illumination
Impact-resistant Surface
Auto Charging

Medium LED Warning Light
TSP-0-0001



Lamp Body Diameter: 11cm
Standard Specification:
Auto sensitive illumination
Impact-resistant Surface
Voltage: 110v/220v/24v/12v

Large LED Warning Light
TWL-10



Lamp Body Diameter: 16cm
Standard Specification:
Auto sensitive illumination
Impact-resistant Surface
Voltage: 110v/220v/24v/12v

Solar Energy Warning Light
SLW1-1



Lamp Body Diameter: 11cm
Standard Specification:
Auto sensitive illumination
Impact-resistant Surface
Auto Charging



**Solar Power Warning Light
Includes Tripod**
BWL-05
Height: 100cm
(The tripod is not open)
Advantages:
Auto illumination in the
nighttime Lamp body of
impact-resistant and
shockproof plastic surface



**Warning Light Includes
Tripod**
BWL-04
Height: 120cm
(The tripod is not open)
Voltage: 110V/220V



**LED Flashing Warning
Light with Storage Battery**
BLWL-01
112cm
Type: LED warning light of
ultra-high brightness
Advantages: 30 LED red l
ights and 30 LED blue lights
Total : 60 lights
Continuous use of 60 hours
Voltage: 110V
Don't charge over 6 hours



**LED Flashing Warning
Light with Storage Battery**
BWL-01
120cm
Type: LED warning light of
ultra-high brightness
Advantages: Auto sensitive
illumination
Continuous use of 60 hours
Voltage: 110V
Don't charge over 6 hours

TRAFFIC BATON/SAFETY VEST/TACTILE WALKING SURFACE INDICATORS

Traffic Baton(2-stage)
C0249-02



1 C batteries*2PC
flashing / fixed light

Traffic Baton(3-stage)
C0249-01



400X500mm
flashing / fixed light /
marquee light
(Charging by hand)

Traffic Baton(Magnetic)
C0249



260mm
Illumination/magnet/
fixed light/flicker
(Charging by hand)

**LED canvas direction
indication light**
TSB-0-00-01



Specification: 50cm(H)*100cm(L)
flashing / fixed light / marquee light
Voltage: 12V / 3 C batteries

**Tactile walking surface
indicators**

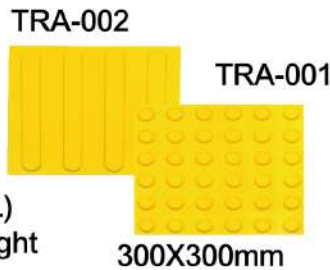

300X300mm

Reflective sleeves
RT-0-01 Nylon
RT-0-02 Mesh



Environment-friendly
RJ-0-00



Velcro-type
RJ-0-01



Zipper-type
RJ-0-04



Traffic Police
RJ-0-0003



Guard-type
RJ-0-05



Japanese V-type
RJ-0-0001



LED-type
LJ-104



No Internet V-type
RJ-0-06



Tight-type
RJ-0-07



Police-type
RJ-0-08



Reflective raincoat
RJ-1-01 Yellow
RJ-1-02 Blue

ROAD SAFETY

Size tolerance $\pm 5\%$

○ PARKING LOCK

Parking Lock

RF-0-0001

500X580X360mm



Bicycle Stand

BF-01

560X190X315mm



Folding Parking Triangular Metal Lock

RF-0-0002

700X220X400mm



Remote Control Electronic Private Parking Lock

RF-0-0003

470x460x70mm



◎ BARRIER(FIXED/MOVABLE)



Board Barrier
AB-03(3 feet)
AB-04(4 feet)



Movable Traffic Barrier
(Thick tube)
BD-127
1275X955mm



Movable Traffic Barrier
(Thin tube)
H01(1200X1000mm)
H02(900X1000mm)



Movable Traffic Barrier
(Square)
CB7002
890X890mm



Movable Traffic Barrier(Creative)
H04
1200X1000mm
Mezzanine 1200X430X18



Movable Traffic Barrier
(Stainless steel)
BD-130
1200X940mm

◎ BARRIER(FIXED/MOVABLE)



H-Type Guardrail

PCG3-10

96x118cm



Iron Guardrail

BD-300

300X120cm



Steel Parking Stop

SP-09-01

200x11cm



ROAD SAFETY

Size tolerance $\pm 5\%$

OTHER SERIES

Luminous



Car Steering Wheel Covers

HC-0-00

180X125X265 mm



Triangle reflective car warning signs

TSB-0-00-03

430X430X390mm



Noise Reducing Earmuffs

HC-0-01/HC-2-02



Movable toilet

HC-3-01 Squatting

HC-3-02 Standing

HC-3-03 Shower

HC-3-04 Squatting+shower



Bathroom

HC-4-00

Squatting/sitting

Helmet required



Face mask

HC-1-01/HC-1-02

Outdoor safety

Playground rubber floor tiles mat

FP-12-1

50X50X5mm

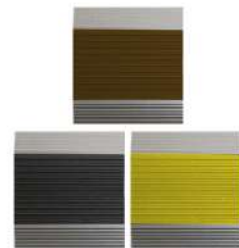

Anti Slip Safety Stair Nosing

S-731

40mm X 4mm(thickness)

OTHER SERIES



Anti-glare board
SW-0-00
915X225X87mm



Anti-glare board
SW-0-01
900X200mm

Rebar safety cap

CDH-345/CDH-678
3/8" .4/8" .5/8" (Share)
6/8" .7/8" .8/8" (Share)
9/8" .10/8" (Share)
11/8" .12/8" (Share)



Golf Yards

OP-01

white/red/blue/yellow

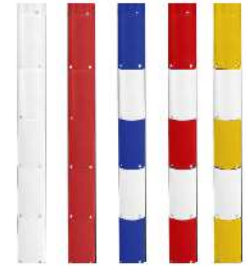

Barrier gate (straight arm)

RF-0-03

Without remote control host



Barrier gate (straight arm)

RF-0-01

Without remote control host



Buffer Pad(For agricultural machinery)

SPM-0-0031

670X630X110mm

660X375X110mm



Halogen Light (Portable)

RC-0-01

500W/2M



Halogen Light

RC-0-02

500W/2M

○ PARKING SPACE COMBINE BAG

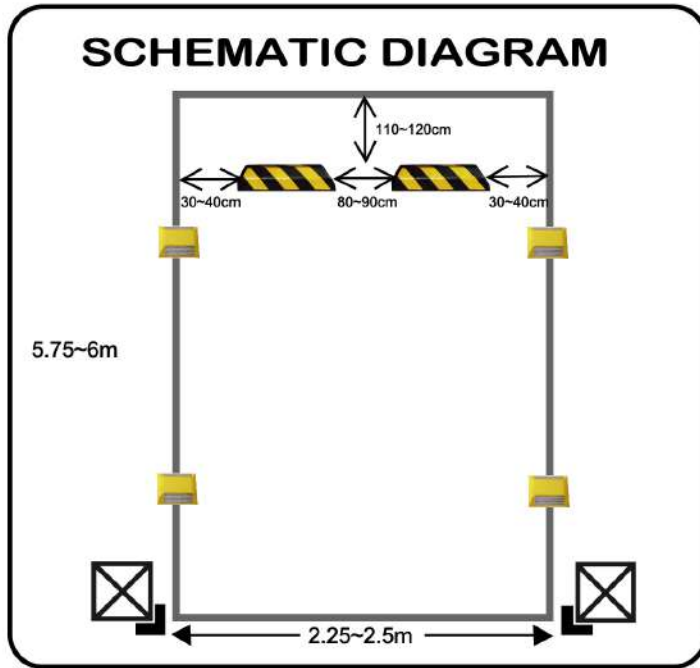

Two L corner guards



Two rubber parking curbs



Four Reflective Pavement Markers



Corner guards

88X88X552mm

CG-0-00-01 Black + yellow

CG-0-00-02 Yellow + green

CG-0-00-03 White + red

Reflective Pavement Markers

LRM02

104X104X18mm

yellow

Rubber Parking Curb

SP-02-01

500X130X130mm



600X400X6mm

RPCS-07



620X240X28mm



RPCS-02-00

630X240X30mm



RPCS-03-00

395X200X15mm

RPA-01



RPCS-02-01



RPCS-03-01



RPCS-02-02



RPCS-03-02

400X197X32mm

RPR-01

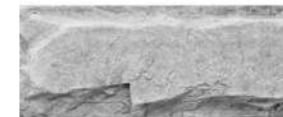

RPCS-02-03



RPCS-03-03



RPCS-02-04



RPCS-03-04

405X207X32mm

RPP-01

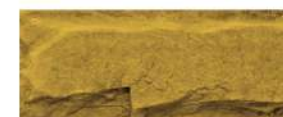

RPCS-02-05



RPCS-03-05

GREEN PLATE

GREEN SUN

GREEN SUN Physical Property Specifications Form

Test Item	Testing Method	Unit	Standard Specification
Hardness	ASTM D412	Shore A	≥ 85
Ultimate Tensile Strength	ASTM D412	Kgf/cm ²	≥ 75
Elongation rate	ASTM D412	%	≥ 55
Impact Strength(r.t.)	ASTM D256	J/M	≥ 200
Impact Strength(-20°C)	ASTM D256	J/M	≥ 150
Tear Strength	ASTM D624	Kgf/cm ²	>30
Specific Gravity 23/23°C	ASTM D792	-	<1.25
Thermal Shrinkage Rate	80°C 6hrs	%	<0.5
Heat Aging	-	168hrs	No cracks or deformation or color distortion in visual inspection
Flexural Strength	ASTM D790	Kgf/cm ²	>80
Thermal Conductivity	CNS 7333	w/m°C	Green Sun Plate <0.2 Composite double layer <0.12
Direct Screw Withdraw Screw #10	ASTM D1037 Screw #10	Kgf	>100
Weatherability	JIS D0205	300hrs	Coated with protective films- Chromatic aberration grade 3—4 Coated without protective films- Chromatic aberration grade 3—4

Outer wall material of the lanes

- It can legibly mark.
- Colors and their arrangement can be customized landscape architecture
- Recycled rubber and plastic material
- Easy to maintain, excellent anti-foul
- It can be applied on the walls of lanes everywhere to avoid damages to the vehicle.



● GREEN SUN Prefabricated Homes



Features:

1. Structure:

light-gauge steel frame* calcium silicate

2. Design:

uses steel construction with calcium silicate board for wall construction and beautification of exteriors utilizing green plate

3. Outside dimension:

187cm(Width), 185cm(Height), 273cm (Front Height), 258cm(Rear Height)

4. Inner space:

37.44 square feet (1.04 Taiwanese ping)

5. Specifications:

A. Roof: painted corrugated sheet

B. Skeleton frame: light-gauge steel frame

C. Wallboard: calcium silicate







D. Floor: Embossed plate

Applications:

1. Construction site
2. Guardhouse
3. Farm tool storage room
4. Resort cabin
5. Ticket window
6. Cafeteria
7. Outdoor storeroom
8. Temporary housing area
9. Betel nut stand
10. Toll booths (parking lot, gas station, road)

GREEN PLATE

5.96 SQUARE FEET (6 SQUARE TAIWANESE FEET)

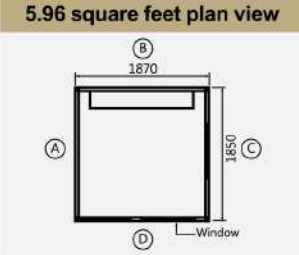
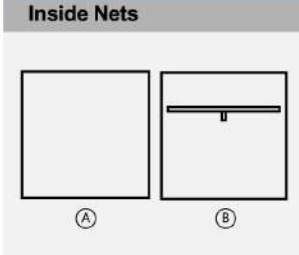
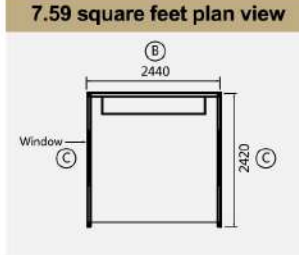
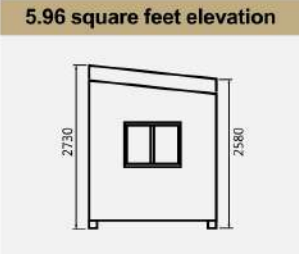
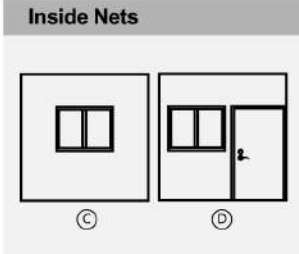
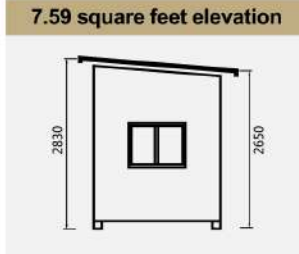
		
Outward	Outward	Green Sun Plate- Series of slate
		
Roof	Window	Green Sun - Close fit with the window
5.96 square feet plan view	Inside Nets	7.59 square feet plan view
		
5.96 square feet elevation	Inside Nets	7.59 square feet elevation
		

7.59 SQUARE FEET (8 SQUARE TAIWANESE FEET)

		
Outward	Outward	Roof
		
Green Sun Plate- Series of plate	Internal	Internal

**SOUND INSULATION WALL / RIVER EMBANKMENT / FENCE
SEA EMBANKMENT LANDSCAPE GREEN BUILDING MATERIAL**



Decorate flowerbed



Embellish wall



Sound insulation

With soundproof cotton

More effective

Flexible combination of color patterns

Quick to tear apart and to install

High weather insulation quality,

No moss growing



Green building toll booths

Noticeable sign

Can prevent collision and damage to vehicles and people.

Customized pattern design

Stereoscopic exterior appearance, customized size



GREEN BUILDING GUARDBOUSES, TOILETS

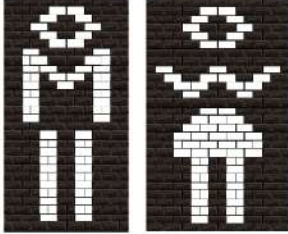

- Flexible combination of many colors
- Rapid construction, cost-saving
- Sound and thermal insulation effect
- Acid and alkali resistance, long service life

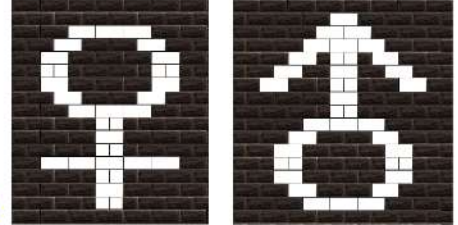

REFURBISHMENT OF OLD HOUSES, RENOVATION, AND THERMAL INSULATION ON THE OUTWARD APPEARANCE OF CONTAINER HOUSES AND METAL HOUSES

- Suitable for fast refurbishment of old buildings in the city
- Direct construction without removal of original walls
- Rapid construction, a significant effect



Before refurbishment



After refurbishment



Before renovation



After renovation

A comprehensive evaluation of the comparative form of materials

Evaluation Categories of materials	Installation	Durability	Weather-resistance	Maintenance	Safety	Sound Insulation	Thermal Insulation	Sound absorption	Installation cost	UV resistance	Traffic views	Pressure-free	Use performance	Green Building Material Certificate
Sheet metal	○	○	○	○	△	○	△	△	○	○	○	△	○	△
Cement board	△	☆	☆	△	△	☆	○	△	☆	○	○	○	○	△
Resin board	○	△	△	△	○	△	○	△	△	△	☆	☆	△	△
Green Sun (Recycled rubber plate)	☆	☆	☆	☆	☆	☆	☆	☆	☆	☆	☆	☆	☆	☆

☆: Good ○: Acceptable △: Bad



Toxicity Characteristic Leaching Procedure (TCLP)

Item	Testing Standard mg/L	Result
T-Hg	0.005	Qualified
Cd	0.3	Qualified
Pb	0.3	Qualified
As	0.3	Qualified
Cr+6	1.5	Qualified
Ag	0.05	Qualified
Cu	0.15	Qualified

* Performance testing was conducted through the Summit Environmental Technologies Co. Ltd.' s Green Building Material Testing and standard methods based on the Environmental Protection Administration of the Executive Yuan and relevant agencies.

Asbestos Identification & Radioactive Measurement

Item	Method	Result
Asbestos Identification	NIEA R401.21T CNS 13970	Non-detected (The item contains no asbestos.)
Radioactive Measurement	Thermo FHT 40 NBR Radioactive Measurement	Non-detected (<0.2μSV/h The item contains not radioactive rays)

*Performance testing was conducted through the Ministry of the Interior' s Performance Experiment Center Architecture and Building Research Institute based on NIEA R401.21 T, CNS 13970 and Thermo FHT40 NBR tests.

Volatile Organic Compounds of Green Building Materials

Item	Efficiency of violate	Result
HCHO	<0.08 mg/m ² , hr	0.002
TVOC	<0.19 mg/m ² , hr	0.163

* The product doesn't include toxic chemical substances and inorganic halogenation, or other chemicals controlled by the Montreal Protocol and announced by the Executive Yuan' s Environmental Protection Administration.

GREEN PLATE

Size tolerance $\pm 5\%$

Dedicated anti-slip mats

High-slip resistance

Prevents people from falling and getting injured

Easy to clean, moss-resistant



RPG-01
900X600X6mm



RPS-01
400X267X3mm

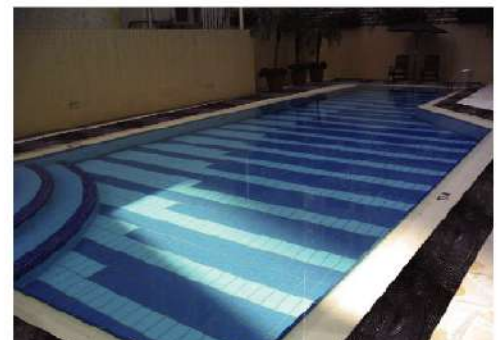

Gym Safety Mat

FP-12

500X500X25mm

TREE GRILLE

Suitable for outdoor landscaping (street trees)

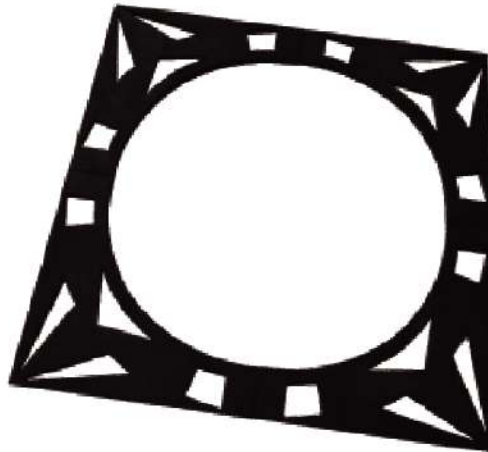

RPTG-01

910X910X12mm

Suitable for uneven grass in the garden or sidewalk, narrow view of the garden or sidewalk which attracts a lot of insects, flies or mosquitoes, with grass barbers and tree grilles, there is a better view of the area and their unique shapes can control weed growth, which can help beautify the city.

GRASS PAVER BLOCK

Suitable for communities, villas, offices, schools, mansions (luxurious gardens), etc.



GB-01

480X340X28mm

Can be used with all kinds of teletext

Fast and simple construction

Shows the diversity and harmony of gardens and sidewalks

Creates an elegant and beautiful garden alia chaotic environment

○ CULTURAL CREATIVE



T-shirt



Flip-Flop



Tote Bags



Suitcase



Thermos



Tablecloths



Mug(Two styles)



Folding Umbrellas



Tile photo frame

CULTURAL CREATIVE



Environment-friendly series
(Taiwan White Bear)

Size:S/M/L/XL

Color:black/white

CULTURAL CREATIVE



Guarding Taiwan Series

(Taiwan Black Bear)

Size:S/M/L/XL

Color:black/white

Taiwan
SUN RUBBER CO., LTD./SUN ROAD SAFETY TECH. CO., LTD
 Head office / No. 63, Ln. 22, Sec. 1, Sinren Rd., Taiping Dist.,
 Taichung City
 TEL: 886-4-22781058
 FAX: 886-4-22788161
 E-mail: service@rubbers.com.tw



North Taiwan / 20F.-3, No. 187, Sec. 2, Huanhe W. Rd., Yonghe
 Dist., New Taipei City
 TEL: 886-2-82313358
 FAX: 886-2-82313328

South Taiwan / No. 66, Dingsin St., Sanmin Dist., Kaohsiung City
 TEL: 886-7-3509750
 TEL: 886-7-3106440
 FAX: 886-7-3108182

China
DONG-GUAN CITY GOLDSUN MIX TECHNOLOGY CO., LTD.
 No. 2, Beier Road, Nan Wu Shouei Koo Village Hou Ju Town,
 Dong-Guan City
 TEL: 002-86-769-85905167
 FAX: 002-86-769-85920167
 E-mail: ty5920167@163.com



www.rubbers.com.tw
 2023.04.Version

TAIWAN PATENT GERMAN PATENT AUSTRALIA PATENT U.S.A PATENT



Green Building Material Golden Hand Award For Outstanding SMEs



Ten Outstanding Models Awards



Model of Entrepreneurs Awards

Industrial Sustainable Excellence Award

PATENT & GLORY

- CHINA PATENT - Steering wheel sheath for vehicle
- CHINA PATENT - Assembled jumping road structure
- CHINA PATENT - Road bump device
- CHINA PATENT - Polishing wheel for emery cloth polishing machine
- CHINA PATENT - Rubber polishing wheel
- CHINA PATENT - Assembled alarm bumper pole
- CHINA PATENT - Delineators
- CHINA PATENT - Polishing wheel for polishing machine
- U.S.A PATENT - Road bump device
- GERMAN PATENT - Road bump device
- AUSTRALIA PATENT - Road bump device

- TAIWAN PATENT - Polishing wheel for emery cloth polishing machine
- TAIWAN PATENT - Steering wheel sheath for vehicle
- TAIWAN PATENT - Improved structure of delineators
- TAIWAN PATENT - Illuminating sign structure
- TAIWAN PATENT - Inventive jumping road structure
- TAIWAN PATENT - Road bump device
- TAIWAN PATENT - Assembled alarm bumper pole
- Taiwan Patent - Method for Manufacturing Composite Environment Friendly Material
- Taiwan Patent - Eco-friendly recycled growth mat for plant and manufacturing method

- SBIR (Small Business Innovation Research) Phase II and Phase II+ Promoting Program in 2008 and 2009
- Golden Hand Award For Outstanding SMEs in 2011
- Green Building Material Marker Certificate in 2010
- The 13th Industrial Sustainable Excellence Award-Livelihood, Chemical Industry in 2012
- Excellent Membership of Taiwan Rubber Industries Association in 2014
- ISO / TS 10467: 2013 Carbon Footprint Verification obtained in 2014
- Received Certificate of Appreciation from Taiwan Research Institute in 2016
- Won the Li Guoding Management Medal in 2017
- Exemplification of Excellence from Ministry of Economic Affairs, R.O.C. in 2019
- Won the Taichung County International Association Enterprise Model Award in 2020
- ISO 9001: 2015 Quality Assurance obtained in 2020
- Robotic arm government subsidy program passed in 2021
- Golden Jade Award obtained in 2021
- Top 50 finalists for the Golden Ship Award obtained in 2021